

The logo for DONE, featuring the word "DONE" in a bold, teal, sans-serif font. The letter "D" is stylized with a white circular element inside its top curve. The logo is enclosed in a thin teal rounded rectangular border.

MXK Series LED Drivers

DL-200H-V286FD-MXK Spec. V1.0

Features

- Suitable for luminaire with protection Class I and II
- Input voltage range: 176-305Vac
- High efficiency up to 93% (Typ.)
- Constant power design and constant current mode
- Adjustable output current (AOC) with NFC or DALI-2 programmer
- Always-on auxiliary power supply : 24V/125mA
- Dim-to-off with standby power ≤ 0.5 W
- Over temperature protection via external NTC
- Complies with Zhaga interface specification Book 13
- Ingress protection rating : IP20
- Input surge protection: DM 6kV, CM 10kV(Class I)
- All-Around protection: IUVP/SCP/OVP/OTP
- 5~8 year warranty



Applications

Road lighting

Industrial lighting

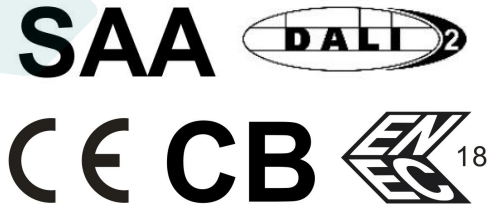

Model list

Model NO.	Input voltage	Output power	Output voltage	Output current	Default current	Eff. (Typ.)	THD (Typ.)	PF (Typ.)
DL-200H-V286FD-MXK	200-277Vac	200W	157-286Vdc	0.5-1.05A	0.7A	93%	7%	0.99

Note : Test conditions for the above parameters: Ta = 25°C, 230 Vac input, 30 minutes full load.

Input characteristics

Parameter	Min	Typ.	Max	Note
Rated input voltage	200Vac	230Vac	277Vac	
Input voltage range	176Vac	-	305Vac	
Input frequency	47Hz	50/60Hz	63Hz	
Leakage current	-	-	0.70mA	IEC 60598-1; 240Vac/60Hz
Power factor(PF)	0.95	0.99	-	At 230Vac,50-60Hz,100% load
	0.90	-	-	At 220~240Vac,50-60Hz,70%~100% load
Total Harmonic Distortion(THD)	-	7%	10%	At 220~240Vac and 70%~100% load
Standby Power	-	-	0.5W	
Input current	-	-	1.2A	At 200Vac and full load conditions
Inrush current	-	-	100A	At 230Vac and 25°C cold start

Output characteristic

Parameter	Min	Typ.	Max	Note
Efficiency@230Vac	91.0%	93.0%	-	At full load conditions
Efficiency@277Vac	91.5%	93.5%	-	At full load conditions
Output voltage range	157Vdc	-	286Vdc	Constant power range: 190-286Vdc
Open circuit voltage	-	-	350Vdc	
Output current range	0.5A	-	1.05A	The NFC or Dali programmer regulates the output current
Output current tolerance	-5%	-	+5%	At full load conditions
Output Current Ripple(PK-AV)	-	5% Iomax	10% Iomax	At full load conditions , 20 MHz BW
Start-up overshoot current	-	-	10%	At full load conditions
Line regulation	-3%	-	+3%	Measured at 100% load,input voltage changes from 200Vac to 277Vac,.
Load regulation	-3%	-	+3%	At 230Vac input and load change from 70% to 100%
Turn-on delay time	-	-	1.0s	At 200~277Vac and full load

Output characteristic

Parameter	Min	Typ.	Max	Note
24V Auxiliary Output Voltage	21.6V	24V	26.4V	
24V Auxiliary Output Source Current	0mA	-	125mA	Return terminal is "DA-/24V-"
24V Auxiliary Output Transient Peak Current @6W	-	-	250mA	250mA peak for a maximum duration of 2.2ms in a 6.0ms period during which time the average should not exceed 125mA.
24V Auxiliary Output Transient Peak Current @10W	-	-	425mA	425mA peak for a maximum duration of 1.3ms in a 5.2ms period during which time the average should not exceed 125mA.

Note: The output current range is limited by the input and output voltage, please refer to I-V Work area curve.

Dimming characteristic

Dimming	Parameter	Min	Typ.	Max	Note
DALI-2	High Voltage Level	9.5V	16V	22.5V	
	Lower Voltage Level	-6.5V	0V	6.5V	Return terminal is "DA-"
	Sink Current	-	-	2.0mA	
Dimming Output Range		0%,10% I_{set}	-	100% I_{set}	

Note: The DALI-2 signal line shares the negative terminal with the 24V auxiliary power supply, which can be used separately or share the negative terminal with the DALI-2 line.

Protection

Parameter		Min	Typ.	Max	Note
External Thermal Protection	R1 (Start derating)	-	1.67KΩ	-	The output current starts to decrease when the actual NTC resistance value is lower than R1, until it reaches R2.
	R2 (Start derating)	-	1.27KΩ	-	When the external NTC resistance is reduced to R2, the output current is reduced to the default 25% current of the programmed setting
	Protection Current Setting Range	20%Iout	25%Iout	100%Iout	Output 25% of Iout current with default external over-temperature protection 流
Over load protection		Hiccup mode , recovers automatically after fault condition is removed.			
Short circuit protection		Hiccup mode , recovers automatically after fault condition is removed			
Over voltage protection		Self-recovery type, automatically recovered after abnormal conditions are removed			
Over temperature protection		Self-recovery type or non-self-recovery type Self-recovery type: when the casing temperature is greater than 90°C, the output power decreases gradually. Default self-recovered.			

Note: The recommended NTC type is 10kΩ NTC, Murata NCP18XH103J03RB.

Environmental

Categories	Parameter
Operating temperature Ta	-40°C ~ +55°C@200-277Vac
Operating case temperature for Safety Tc_s	-40°C ~ +90°C
Operating case temperature for Warranty Tc_w	-40°C ~ +75°C, 10% ~ 95% RH
Storage temperature, humidity	-40°C ~ +80°C, 10% ~ 95% RH
Resistant to vibration	10Hz ~ 500Hz, 5G 12 min/cycle, X, Y, Z axis 72 min each
MTBF	230K hours (MIL-HDBK-217F), Ta=25°C, 230Vac, 80% load
Lifetime	80,000 hours @Tc≤75°C, 230Vac, 80% Load

Safety

Safety Categories	Area	Standards	Approved
CCC	China	GB 19510.1, GB 19510.14	
CE	Europe	EN 61347-1, EN 61347-2-13	√
ENEC		EN 62384	√
CB	CB member state	IEC 61347-1, IEC 61347-2-13	√
SAA	Australia	AS/NZS 61347.1, AS/NZS 61347.2.13	√
UL	USA	UL 8750	
CUL	Canada	CSA C22.2 No.250.13	
BIS	India	IS 15885(PART 2/SEC 13)	

EMC

EMI/EMS Categories	Area	Standards	Approved
CCC	China	GB/T 17743, GB 17625.1	
CE	Europe	EN IEC 55015 EN 61547 EN IEC 61000-3-2;3-3;4-5	√
FCC	USA	FCC Part 15 Subpart B	

RoHS

Our products comply with reference to RoHS Directive (EU) 2015/863 amending 2011/65/EU.

Safety Test Items:

Safety Test Item	UL	CE/CB/ENEC	CCC	Insulation Requirements
Input-output	-	3200Vac	-	Reinforced insulation, 1min < 5mA
Input-Case/Ground	-	3200Vac	-	Basic insulation, 1min < 5mA
Input-Dim	-	1600Vac	-	Reinforced insulation, 1min < 5mA
Output-Case/Ground	-	3400Vac	-	Basic insulation, 1min < 5mA
Output-Dim	-	1700Vac	-	Basic insulation, 1min < 5mA
Dim-Case	-	500Vac	-	
Insulation Resistance		≥10MΩ		Input-Dim, Test voltage: 500Vdc
Ground Resistance		≤0.1Ω		25A/1min; Ta=25°C±10°C

Note: The drive is the component used with the end equipment. As the operational performance of the equipment may be affected by the installation, the final equipment must be tested after installation to ensure that it complies with the EMC Directive.

I-V Working area

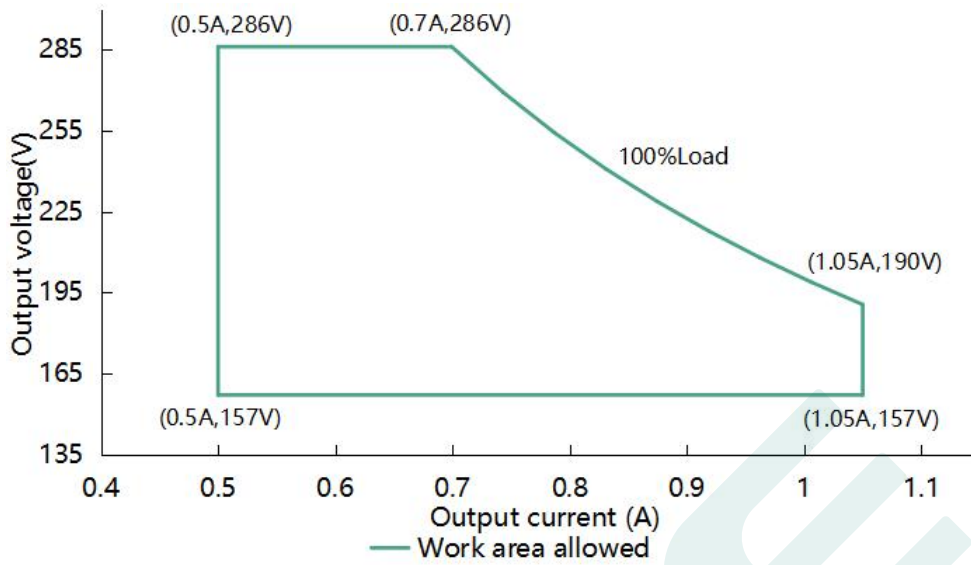

Load	Output parameter								
Output Voltage	157V	168V	179V	190V	214V	232V	250V	268V	286V
Output Current	1.05A	1.05A	1.05A	1.05A	0.94A	0.87A	0.80A	0.75A	0.70A
Output Power	165W	176W	188W	200W	200W	200W	200W	200W	200W

Inrush current

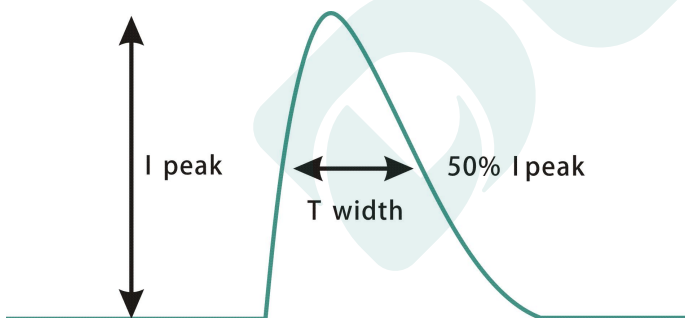

Input voltage	Peak current	T(@50% Peak current)
230Vac	86.0A	165us

Eff. vs. Load

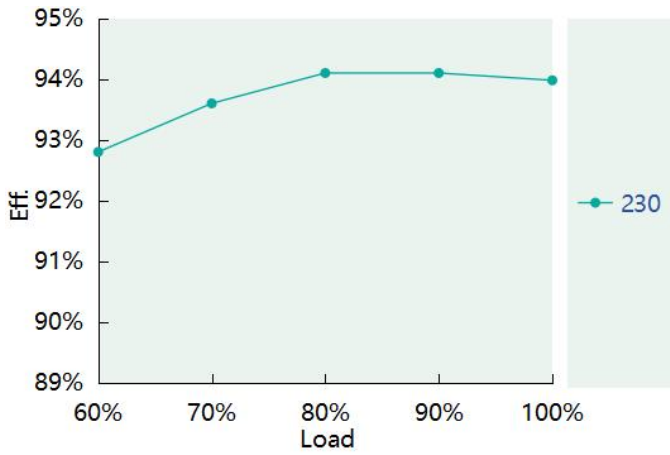

Power Factor vs. Load

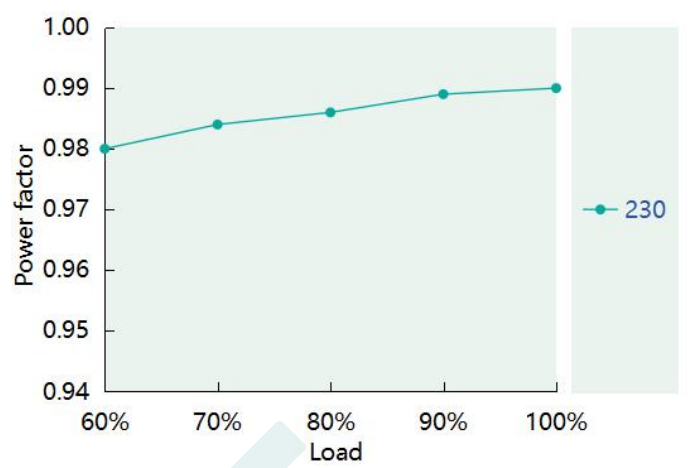

THD vs. Load

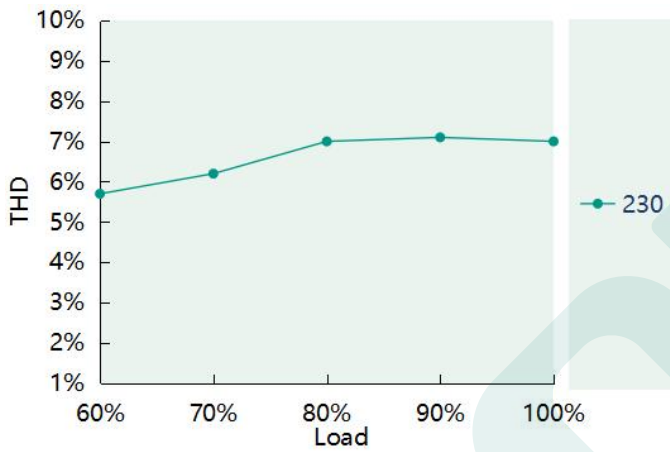

Tcase vs. Lifetime

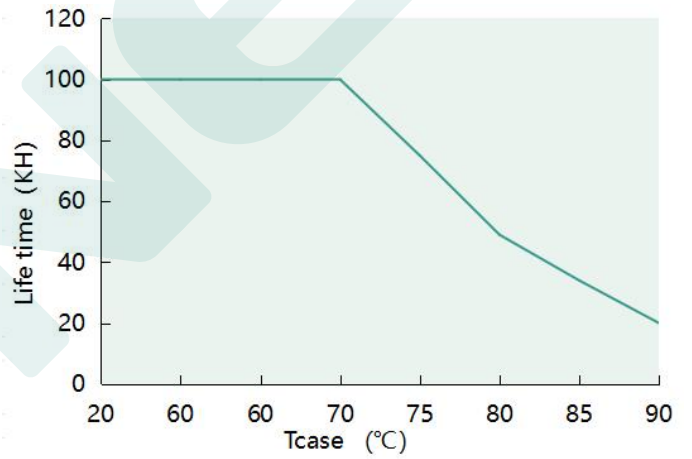

Output power vs. Tcase

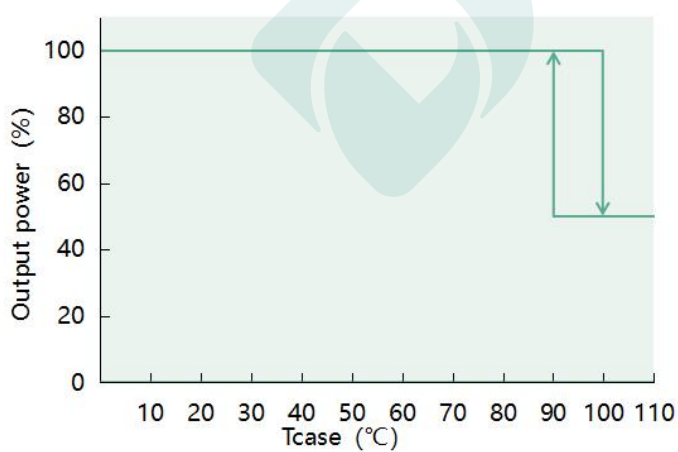

Dimming

- **DALI-2 dimming**

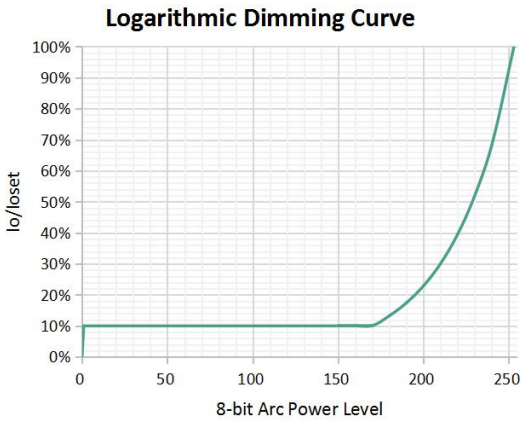

Note: Factory Default Output Logarithmic Curve.

- **Time dimming**

Time dimming control includes 3 kinds of modes, they are Self Adapting-Midnight, Self Adapting-Percentage and Traditional Timer.

1. Self Adapting-Midnight: Automatically adjusts the dimming curve based on the on-time of past two days, assuming that the midpoint of the dimming curve is exactly midnight locally,
2. Self Adapting-Percentage: Automatically adjusts the working time according to the set percentage of time based on the actual working time of each day for the past two days.
3. Traditional Timer: When the power is switched on, the driver works according to the preset dimming time. Set by the programmer, the default is divided into 6 segments, the maximum total time can be set to 19 hours.

Note:

1. Priority: When selecting time control dimming, if there is DALI signal input, it will automatically switch to DALI signal control. After re-powering or no DALI signal, the time-controlled dimming mode is restored.
2. Two days in the above text refers to two adjacent days, and the duration of power-on are more than two hours, while the difference in the duration of two days of power-on is not more than 15 minutes.

Programmable Connections

1. DALI-2 programmer:

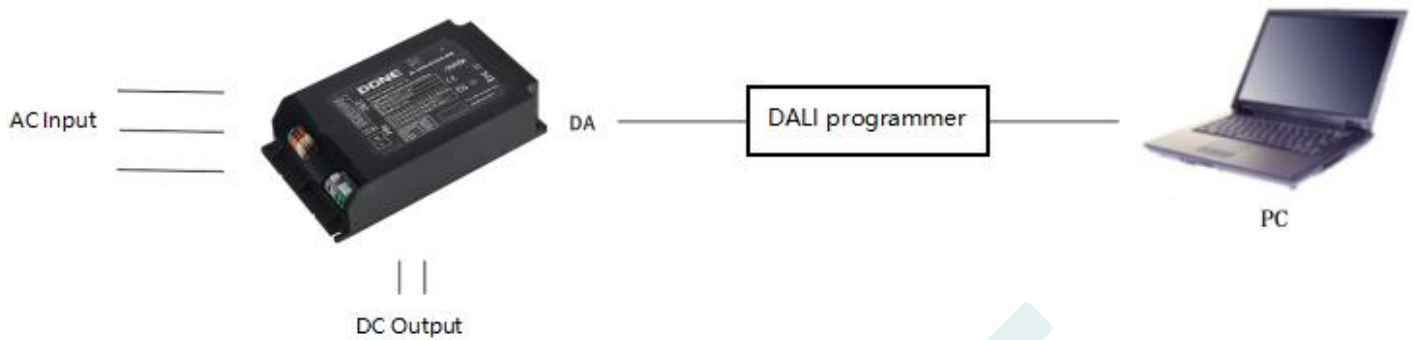

2. NFC programmer



Notes:

1. The driver does not need to be powered on during the programming process.
2. Please refer to DONE DALI-2 or NFC programmer data sheet for details.
3. Applicable to FEIG programmer: ISC PRH101 and CPR30-USB

Mechanical specification

Size (mm) L171*W101*H39

DL-200H-V286FD-MXK

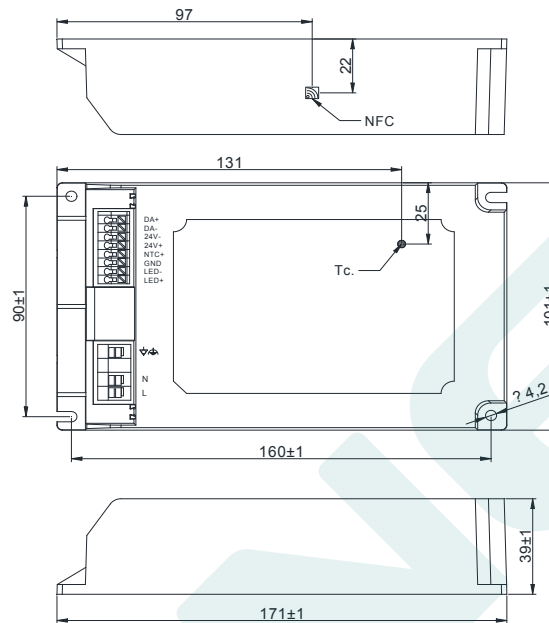

Note:The driver is a Class I/II compatible design and when used in Class II, it is recommended that the Equipotential Ground EQUI is connected to the metal housing of the luminaire to give the lamp better EMI and surge immunity.

Connections

Parameter		Min	Typ.	Max	Notes
L, N, PE	Wire Cross-section	0.5 mm ²	-	1.5 mm ²	Push-in at 0°angle, solid and stranded wire
	Strip Length	8.5mm	-	9.5mm	
LED+, LED-, NTC-, NTC+, 24V+, DA+, DA-	Wire Cross-section	0.5 mm ²	-	1.5 mm ²	Push-in at 45°angle, solid and stranded wire
	Strip Length	8.5mm	-	9.5mm	

Weight

Weight 780 g

Packaging

Packaging (mm) L370*W220*H240

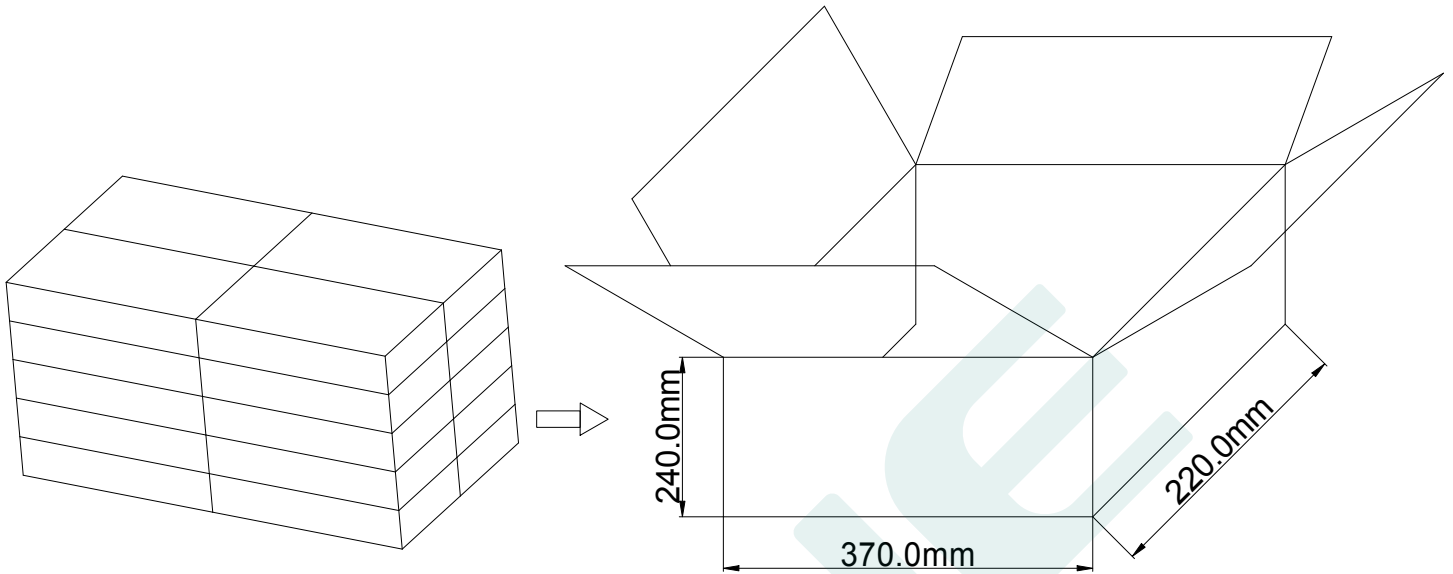

Note: One Carton 5 layers and 4 pcs each layer, total 20pcs/carton.

Note:

1. According to the certificate obtained by the LED DRIVER, the LED DRIVER with the English label is sold in Europe, America and India.
2. The LED DRIVER with Chinese label is only used for China market.

Version

DATE	DESCRIPTION	REV.	CHECK
2025.10.13	Initial version.	V1.0	

MANUFACTRUER		
EDIT	CHECK	APPROVE